

cod.	mm.	pz/pcs	L	R	passanti
206.130	130	10	130	2-40	1
206.300	300	10	300	2-40	2
206.500	500	10	500	2-40	2



Block-system



Galvanized steel components



- Components to weld
- Adequately strengthen the areas anchoring the door and/or structure / frame.



Check the product every 6/12 months.
In case of anomalies, prevent the usage of the hinge and the installed product must be checked by professional personnel.



Responsibly dispose of the product and of its packaging respecting the local legislations of the Country of installation.

The company reserves the right to make technical as well as aesthetic changes without previous notice.
All responsibility due to an inappropriate use of the product is declined.

All drawings, photos, trademarks, logos, are of exclusive Combi Arialdo's property. All uses not expressly authorized by the company will be prosecuted.

1

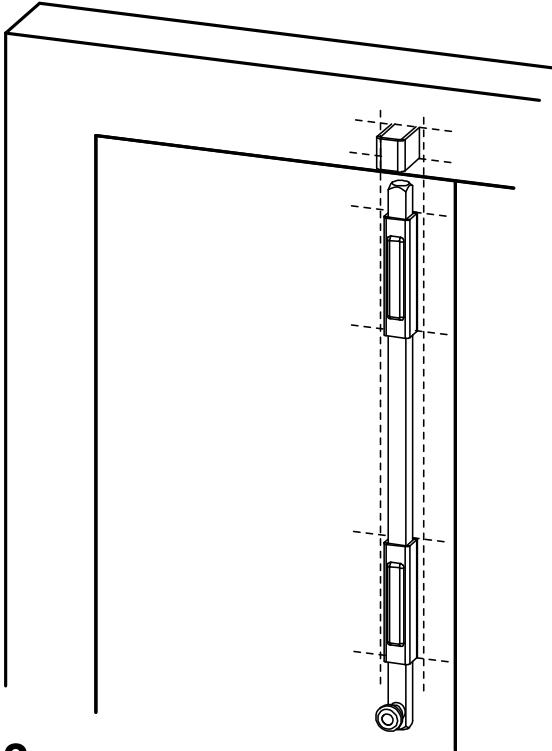

2

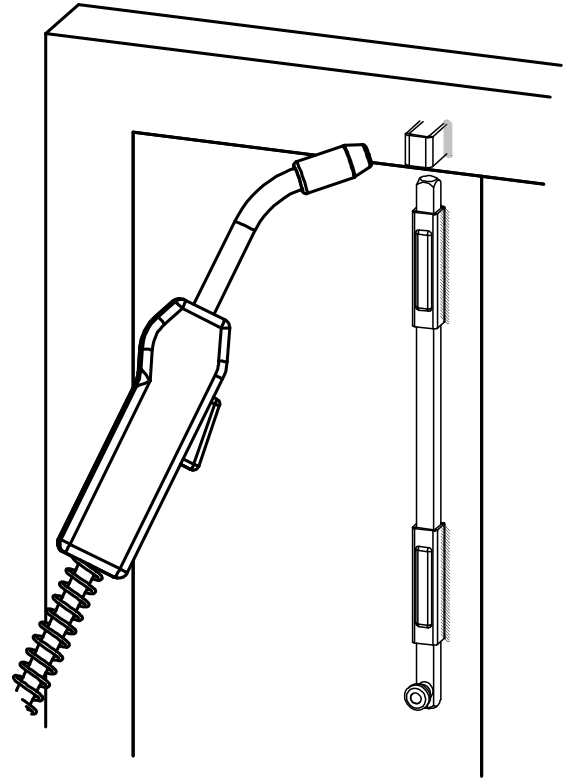

3

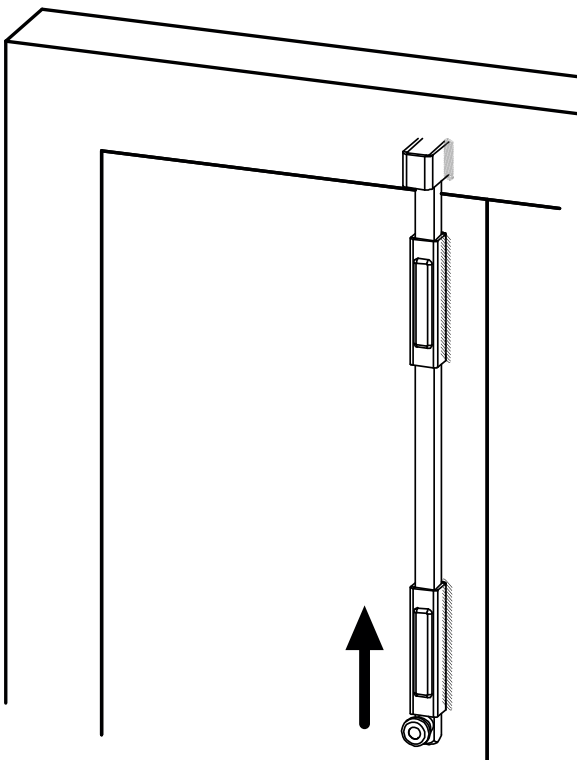

ART. 205

ART. 210

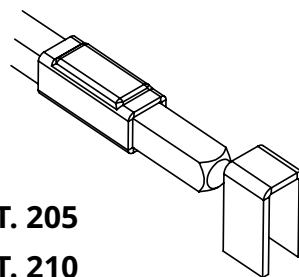

ART. 206

ART. 211

