

cod.	versione	pz/pcs	finitura
501.N	NERO	25	verniciato nero



Accessori



Componenti in Acciaio Verniciato/Tropicalizzato



• Componente da fissare.



• Ogni 6/12 mesi controllare il prodotto.
• Nel caso si riscontrino delle anomalie, impedirne l'uso e far verificare il prodotto installato da personale professionale.



Smaltire responsabilmente il prodotto e le sue parti d'imballaggio rispettando le normative locali nel Paese d'installazione.

L'azienda si riserva di apportare modifiche tecniche ed estetiche senza nessun preavviso. Si declina ogni responsabilità per uso improprio dei prodotti. Ogni disegno, fotografia, marchio, logo, deve intendersi come proprietà esclusiva della Combi Arialdo. Tutti gli utilizzi non autorizzati saranno perseguiti penalmente.

1

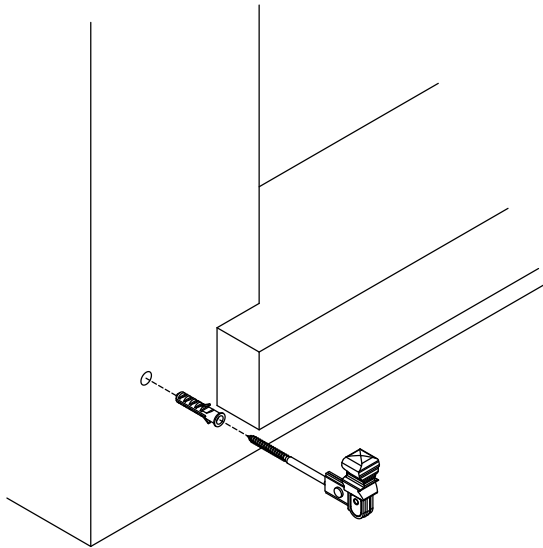

2

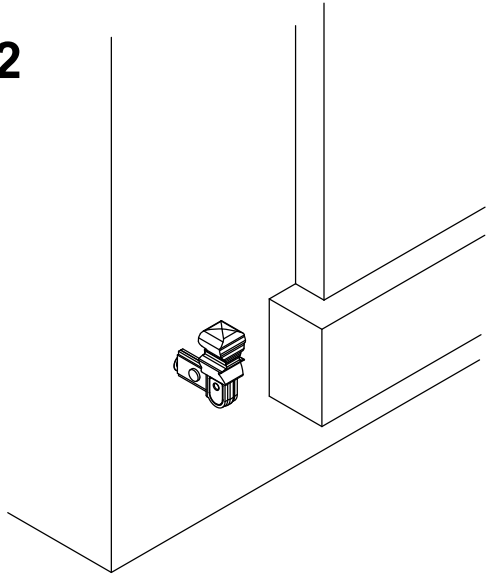

3

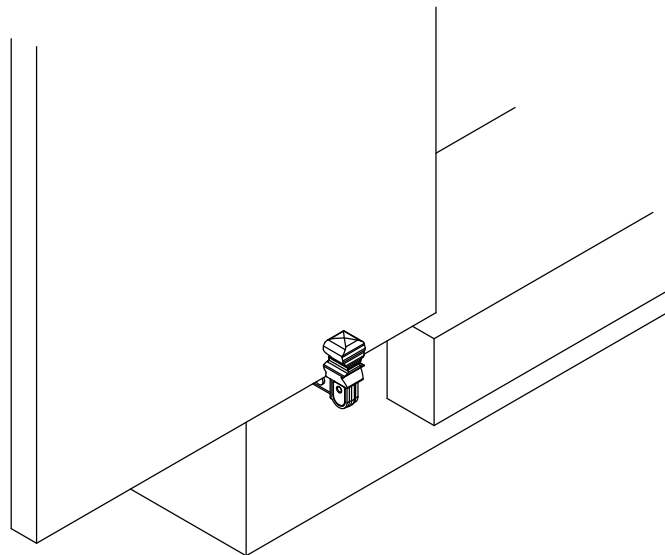

ART. 500

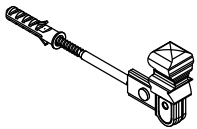

ART. 501

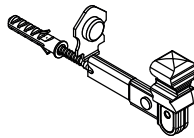

ART. 502

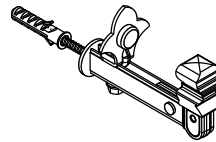

ART. 503

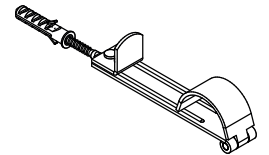

ART. 504

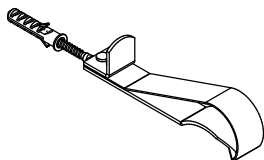

ART. 505

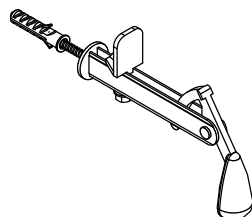

ART. 507

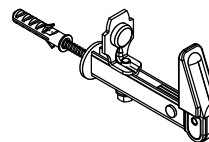

ART. 511

