

cod.	mm.	pz/pcs
702	UNICA	50



Hardware



Steel components



- Components to weld
- Adequately strengthen the areas anchoring the door and/or structure / frame.



Responsibly dispose of the product and of its packaging respecting the local legislations of the Country of installation.

The company reserves the right to make technical as well as aesthetic changes without previous notice.

All responsibility due to an inappropriate use of the product is declined.

All drawings, photos, trademarks, logos, are of exclusive Combi Arialdo's property. All uses not expressly authorized by the company will be prosecuted.

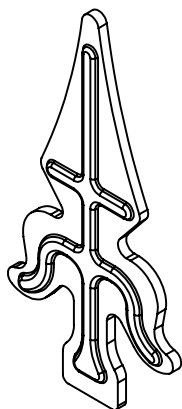
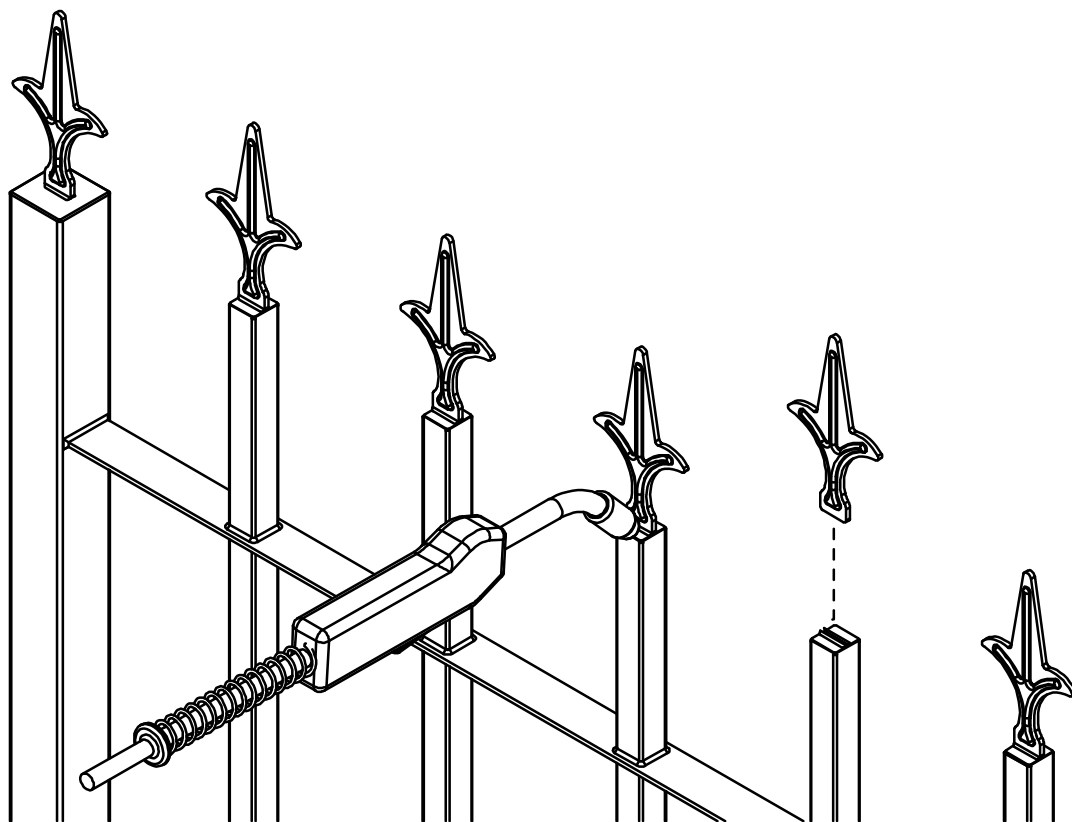

ART. 700

ART. 702

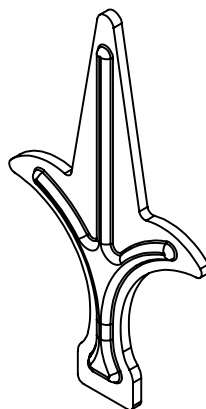

ART. 701

ART. 703

