

cod.	mm.	pz/pcs	ØD	ØF	R
1640.30	Ø30	50	Ø30	Ø10.5	23 - 33
1640.35	Ø35	50	Ø35	Ø14.5	23 - 33



Swing gates accessories



Galvanized steel components



- Components to weld
- The weld must be adequately sized to support the applied forces and with suitable electrode material.
- Adequately strengthen the areas anchoring the door and/or structure / frame.



Responsibly dispose of the product and of its packaging respecting the local legislations of the Country of installation.

The company reserves the right to make technical as well as aesthetic changes without previous notice.

All responsibility due to an inappropriate use of the product is declined.

All drawings, photos, trademarks, logos, are of exclusive Combi Arialdo's property. All uses not expressly authorized by the company will be prosecuted.

1

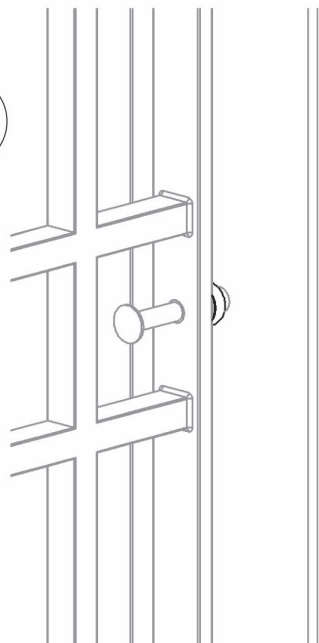

2

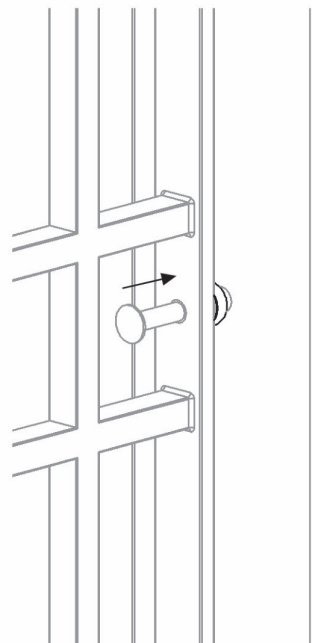

3

